



B-SAFETY[®]
PROFESSIONAL SAFETY SOLUTIONS

DE BEDIENUNGSANLEITUNG

SV BRUKSANVISNINGAR

EN OPERATING INSTRUCTIONS

FI KÄYTTÖOHJEET

FR MODE D'EMPLOI

RU РУКОВОДСТВО ПО ЭКСПЛУАТАЦИИ

IT ISTRUZIONI PER L'USO

PL INSTRUKCJA OBSŁUGI

ES INSTRUCCIONES DE OPERACIÓN

CS NÁVOD K OBSLUZE

PT MANUAL DE INSTRUÇÕES

RO INSTRUCȚIUNI DE OPERARE

NL BEDIENINGSINSTRUCIES

HU HASZNÁLATI UTASÍTÁS

DA BRUGSANVISNING

ZH 操作说明

NO BRUKSANVISNING

JA 操作方法



① DE ANWENDUNG EN APPLICATION FR UTILISATION IT APPLICAZIONE ES APLICACIÓN
 PT APLICAÇÃO NL AANVRAAG DA ANSØGNING NO APPLIKASJON SV ANSÖKAN FI HAKEMUS
 RU НАЗНАЧЕНИЕ PL APLIKACJA CS APLIKACE RO APLICAȚIE HU ALKALMAZÁS ZH 应用
 JA アプリケーション

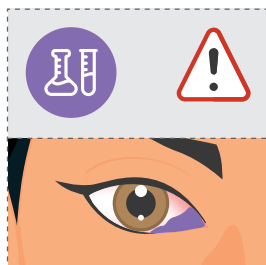

② DE HINWEISE EN NOTES FR INDICATIONS IT NOTE ES NOTAS PT NOTAS NL OPMERKINGEN
 DA NOTER NO TIPS SV ANMÄRKNINGAR FI HUOMAUTUKSET RU ПОДСКАЗКИ PL UWAGI
 CS POZNÁMKY RO NOTE HU MEGJEGYZÉSEK ZH 笔记 JA 備考

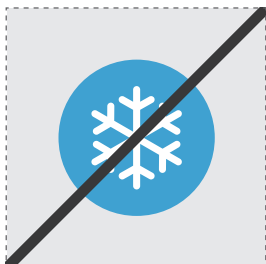
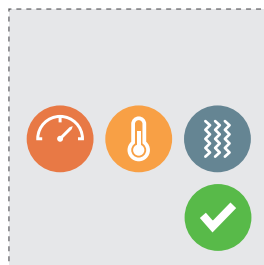
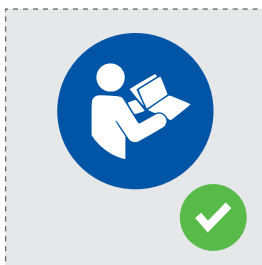

③ DE NORMEN EN STANDARDS FR NORMES IT NORME ES NORMAS PT NORMAS NL NORMEN
 DA STANDARDER NO NORMER SV STANDARDER FI NORMIT RU НОРМЫ PL NORMY
 CS STANDARDER RO APLICAȚIE HU NORMÁK ZH 标准 JA 規格



✓ EN 15154-2:2006
 ✓ ANSI Z358.1-2014



④ DE BETRIEBSDRUCK EN OPERATING PRESSURE FR PRESSION DE SERVICE IT PRESSIONE D'ESERCIZIO
 ES PRESIÓN DE FUNCIONAMIENTO PT PRESSÃO DE FUNCIONAMENTO NL BEDRIJFSDRUK DA DRIFTSTRYK
 NO DRIFTSTRYKK SV ARBETSTRYCK FI KÄYTTÖPAINO RU РАБОЧЕЕ ДАВЛЕНИЕ PL CIŚNIENIE ROBOCZE
 CS PROVOZNÍ TLAK RO PRESIUNEA DE FUNCȚIONARE HU ŰZEMI NYOMÁS ZH 操作压力 JA 作動压力

x1



☹ Min. 1.5 bar g
 ☹ Max. 5 bar g

x2



☹ Min. 2.5 bar g
 ☹ Max. 5 bar g

⑤ DE VOLUMENSTROM EN FLOW RATE FR DÉBIT VOLUMIQUE IT FLUSSO DI VOLUME ES FLUJO DE
 VOLUMEN PT FLUXO DE VOLUME NL VOLUMESTROOM DA VOLUMENSTRØM NO VOLUMSTRØM
 SV VOLYMFLODE FI TILAVUUSVIRTA RU ВОЛУМЕНСТРОМ PL PRZEPŁYW OBJĘTOŚCIOWY
 CS OBJEMOVÝ TOK RO FLUXUL DE VOLUM HU TÉRFOGATÁRAM ZH 体积流量 JA ホリユームフロー

x1



☹ Min. 1.5 bar g
 ☹ 7 L / min.

x2



☹ Min. 2.5 bar g
 ☹ 14 L / min.

6 DE WASSERVERSORGUNG EN WATER SUPPLY FR ALIMENTATION EN EAU IT FORNITURA D'ACQUA
 ES SUMINISTRO DE AGUA PT ABASTECIMENTO DE ÁGUA NL WATERVOORZIENING DA VANDFORSYNING
 NO VANNTILFØRSEL SV VATTENFÖRSÖRJNING FI VESIHUOLTO RU ПОДАЧА ВОДЫ PL ZAOPATRZENIE
 W WODĘ CS ZÁSOBOVÁNÍ VODOU RO ALIMENTAREA CU APĂ HU VÍZELLÁTÁS ZH 供水 JA 水の供給



- ✓ DIN 1988
- ✓ EN 1717



- ⓘ B-SAFETY: 20°C – 25°C
- ⓘ EN 15154-2:2006:
15°C – 37°C
- ⓘ ANSI Z358.1-2014:
16°C – 38°C



- ⓘ EN 15154-2:2006:
Min. 15 min.
- ⓘ ANSI Z358.1-2014:
Min. 15 min.



ⓘ Min. 1.5 bar g
 ⓘ 7 L / min.



ⓘ Min. 2.5 bar g
 ⓘ 14 L / min.



ⓘ Min. 1/2 "



ⓘ Min. 1/2 "



ⓘ Anti-Shock
 Device



7 DE STANDORT EN LOCATION FR EMBLACEMENT IT POSIZIONE ES UBICACIÓN PT LOCALIZAÇÃO
 NL LOCATIE DA PLACERING NO PLASSERING SV PLATS FI SIJAINTI RU МЕСТО РАСПОЛОЖЕНИЯ
 PL LOKALIZACJA CS UMÍSTĚNĚNÍ RO LOCAȚIE HU HELYSZÍN ZH 地点 JA 所在地

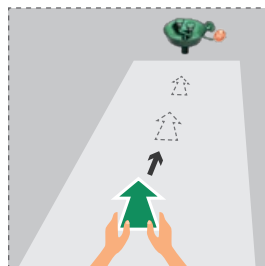
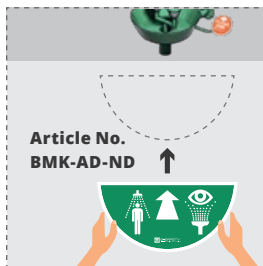
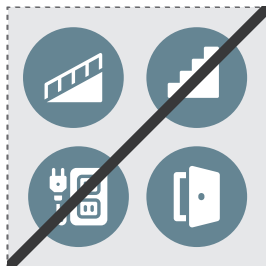
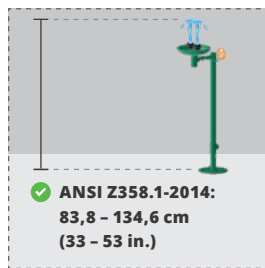
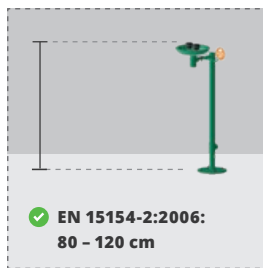
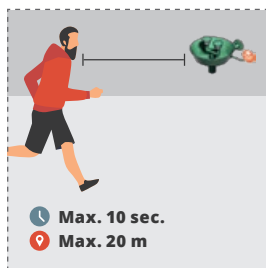
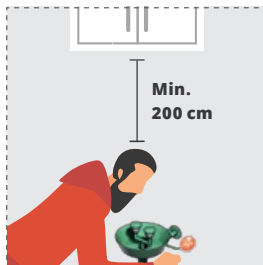
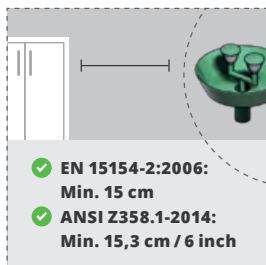

8 DE INSTALLATION EN INSTALLATION FR INSTALLATION IT INSTALLAZIONE ES INSTALACIÓN
 PT INSTALAÇÃO NL INSTALLATIE DA INSTALLATION NO INSTALLASJON SV INSTALLATION
 FI ASENNUS RU МЕСТО И ВЫСОТА УСТАНОВКИ PL INSTALACJA CS INSTALACE RO INSTALARE
 HU TELEPÍTÉS ZH 安装 JA インストール

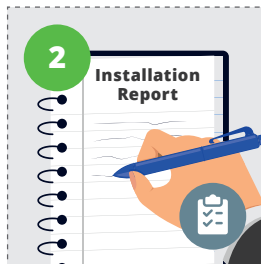
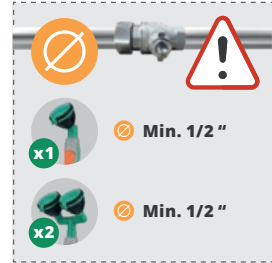
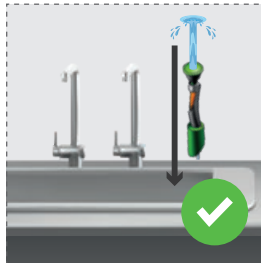
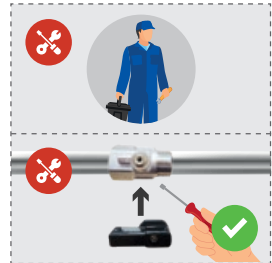
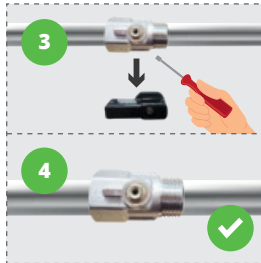
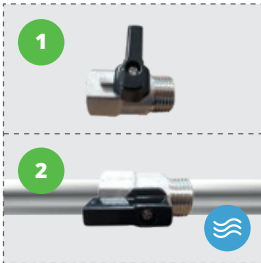

9 DE WASSERSCHLAG VERMEIDEN **EN** AVOID WATER HAMMER **FR** ÉVITER LE COUP DE BÉLIER
IT EVITARE IL COLPO D'ARIETE **ES** EVITAR EL GOLPE DE ARIETE **PT** EVITAR GOLPE DE ARIETE
NL VOORKOM WATERSLAG **DA** UNDGÅ VANDSLAG **NO** UNNGÅ VANNSLAG **SV** UNDVIK
 TRYCKSTÖTAR **FI** VÄLTÄ VESIVASARA **RU** ИЗБЕГАЙТЕ ГИДРОУДАРА **PL** UNIKAJ UDERZEŃ
 HYDRAULICZNYCH **CS** ZABRAŇTE VODNÍMU RÁZU **RO** EVITAȚI ȘOCUL HIDRAULIC
HU KERÜLJE A VÍZÜTÉS **ZH** 避免水锤 **JA** ウォーターハンマーを防ぐ

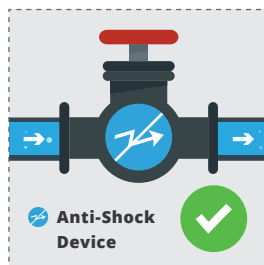
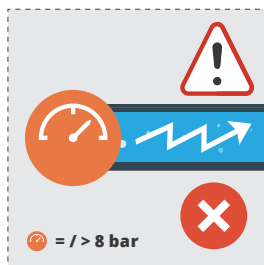
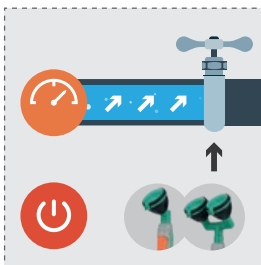
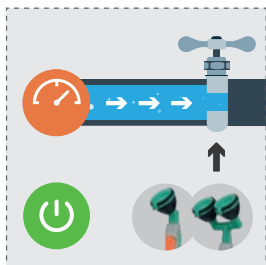

⑩ DE KENNZEICHNUNG EN LABELLING FR MARQUAGE IT MARCATURA ES MARCADO
PT MARCAÇÃO NL MARKERING DA MÆRKNING NO MERKING SV MÆRKNING FI MERKINTÄ
RU МАРКИРОВКА PL ZNAKOWANIE CS OZNAČOVÁNÍ RO MARCARE HU JELÖLÉS ZH 标记
JA マーキング

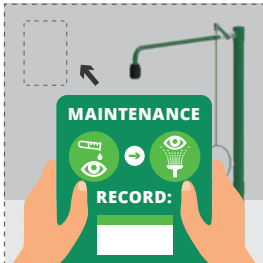
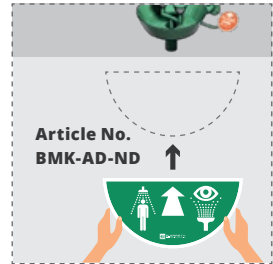
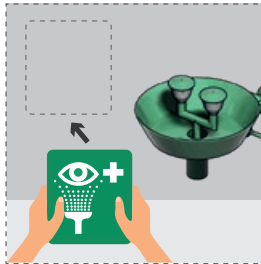

11 DE BETRIEB EN OPERATION FR SERVICE IT OPERAZIONE ES OPERACIÓN PT OPERAÇÃO
NL OPERATIE DA OPERATION NO VIRKSOMHET SV OPERATION FI OPERAATIO
RU ПРЕДУПРЕЖДАЮЩАЯ МАРКИРОВКА PL OPERACJA CS OPERACE RO OPERAȚIUNEA
HU MŰVELET ZH 运作 JA 操作方法



12 DE UNFALLVERHÜTUNG EN ACCIDENT PREVENTION FR PRÉVENTION D'ACCIDENTS IT PREVENZIONE DEGLI INCIDENTI ES PREVENCIÓN DE ACCIDENTES PT PREVENÇÃO DE ACIDENTES NL PREVENTIE VAN ONGEVALLLEN DA FOREBYGGELSE AF ULYKKER NO ULYKKESFOREBYGGING SV FÖREBYGGANDE AV OLYCKOR FI ONNETTOMUUKSIEN ENKÄISY RU ЭКСПЛУАТАЦИЯ PL ZAPOBIEGANIE WYPADKOM CS PREVENCE NEHOD RO PREVENIREA ACCIDENTELOR HU BALESETMEGELŐZÉS ZH 事故预防 JA 事故防止

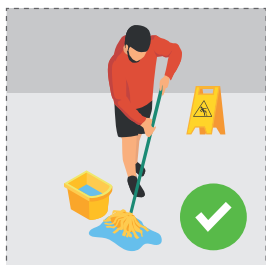

13 DE FUNKTIONSPRÜFUNG, WARTUNG EN FUNCTION CHECK, MAINTENANCE FR CONTRÔLE DE FONCTIONNEMENT, MAINTENANCE IT TEST DI FUNZIONAMENTO, MANUTENZIONE ES PRUEBA DE FUNCIONAMIENTO, MANTENIMIENTO PT TESTE DE FUNCIONAMENTO, MANUTENÇÃO NL FUNCTIETEST, ONDERHOUD DA FUNKTIONSTEST, VEDLIGEHODELSE NO FUNKSJONSTEST, VEDLIKEHOLD SV FUNKTIONSTEST, UNDERHÅLL FI TOIMINTATESTI, HUOLTO RU ФУНКЦИОНАЛЬНЫЙ ТЕСТ, ТЕХНИЧЕСКОЕ ОБСЛУЖИВАНИЕ PL TEST DZIAŁANIA, KONSERWACJA CS FUNKČNÍ TEST, ÚDRŽBA RO TEST DE FUNCTIONARE, ÎNTREȚINERE HU FUNKCIÓVIZSGÁLAT, KARBANTARTÁS ZH 功能测试、维护 JA 機能テスト、メンテナンス

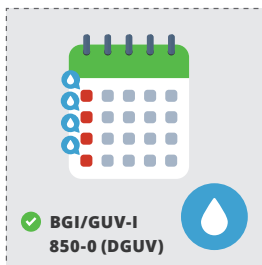

14 DE ERSATZ- UND VERSCHLEISSARTIKEL **EN** SPARE AND WEAR PARTS **FR** PIÈCES DE RECHANGE ET D'USURE **IT** RICAMBI E PARTI SOGGETTE A USURA **ES** PIEZAS DE REPUESTO Y DE DESGASTE **PT** PEÇAS SOBRESSALENTES E DE DESGASTE **NL** RESERVE- EN SLIJTAGEONDERDELEN **DA** RESERVEDELE OG SLIDDELE **NO** RESERVEDELER OG SLITASJEDELER **SV** RESERVDELAR OCH SLITDELAR **FI** VARA- JA KULUTUSOSAT **RU** ЗАПАСНЫЕ И ИЗНАШИВАЕМЫЕ ДЕТАЛИ **PL** CZĘŚCI ZAMIENNE I EKSPLOATACYJNE **CS** NÁHRADNÍ A OPOTŘEBITELNÉ DÍLY **RO** PIESE DE SCHIMB ȘI DE UZURĂ **HU** PÓTKATRÉSZEK ÉS KOPÓALKATRÉSZEK **ZH** 备件和易损件 **JA** 交換部品および消耗部品

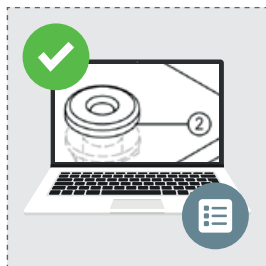

Homepage

15 DE REINIGUNG **EN** CLEANING **FR** NETTOYAGE **IT** PULIZIA **ES** LIMPIEZA **PT** LIMPEZA **NL** SCHOONMAKEN **DA** RENGØRING **NO** RENGJØRING **SV** RENGÖRING **FI** PUHDISTUS **RU** ОЧИСТКА **PL** CZYSZCZENIE **CS** ČIŠTĚNÍ **RO** CURĂȚARE **HU** TISZTÍTÁS **ZH** 清洁 **JA** クリーニング

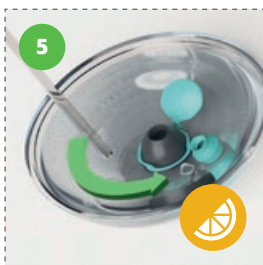
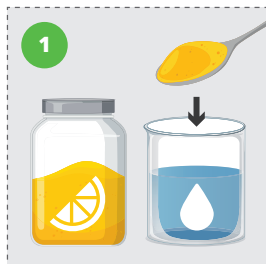

16 DE STÖRUNG EN FAULTS FR DÉFAUTS IT MALFUNZIONAMENTO ES MAL FUNCIONAMIENTO
 PT MAU FUNCIONAMENTO NL STORING DA FUNKTIONSFEJL NO UORDEN SV FUNKTIONSSTÖRNING
 FI TOIMINTAHÄIRIÖ RU НЕПОЛАДКИ PL NIEPRAWIDŁOWE DZIAŁANIE CS PORUCHA RO DEFECȚIUNE
 HU ÜZEMZAVAR ZH 运作故障 JA 誤動作

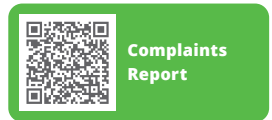
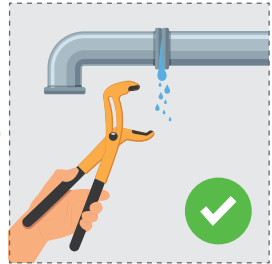
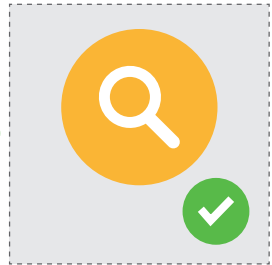

⑰ DE ENTSORGUNG EN DISPOSAL FR ÉLIMINATION IT SMALTIMENTO ES ELIMINACIÓN
PT ELIMINAÇÃO NL VERWIJDERING DA BORTSKAFFELSE NO AVHENDING SV BORTSKAFFANDE
FI HÄVITTÄMINEN RU УТИЛИЗАЦИЯ PL USUWANIE CS LIKVIDACE RO ELIMINARE HU ELTÁVOLÍTÁS
ZH 废弃处理 JA 廃棄

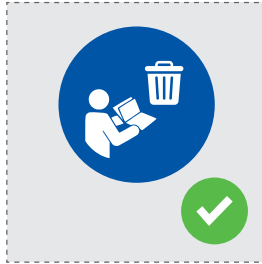

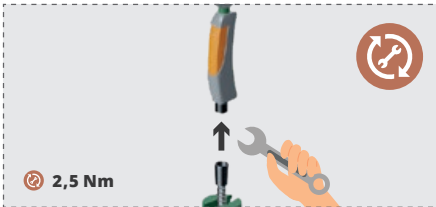
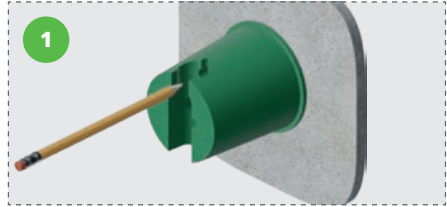

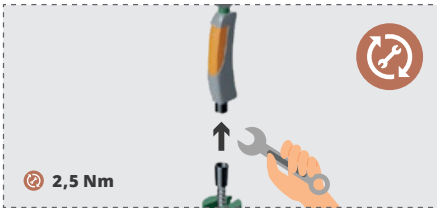
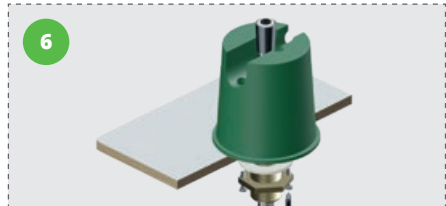
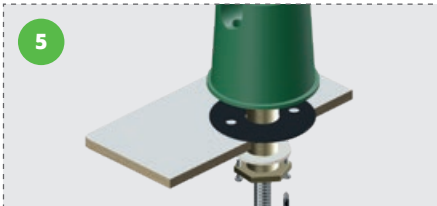
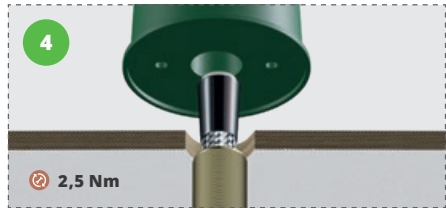
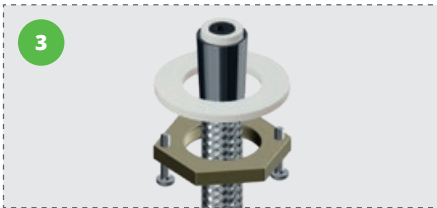
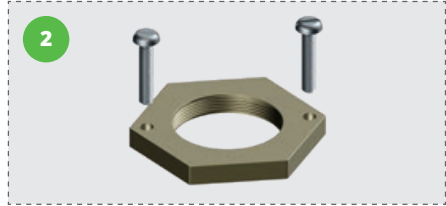
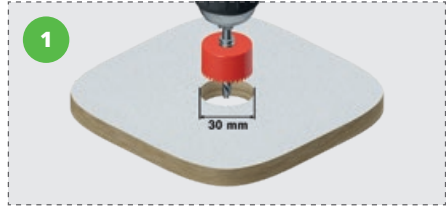
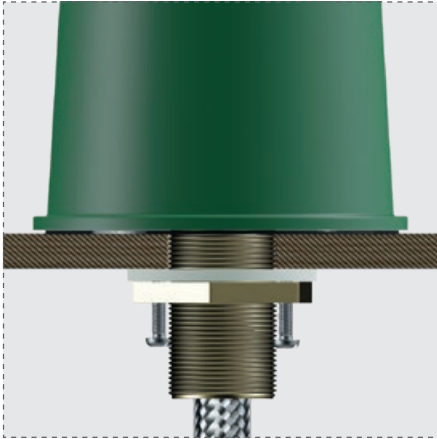

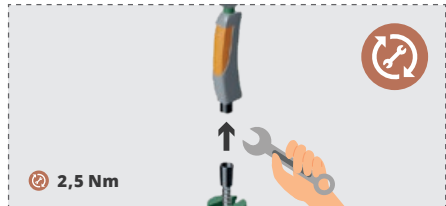
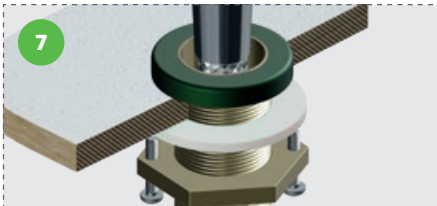
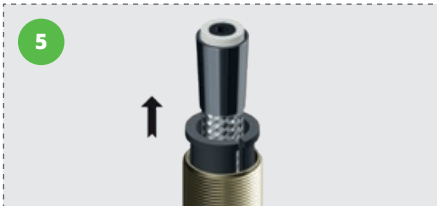
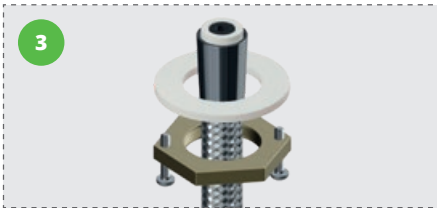
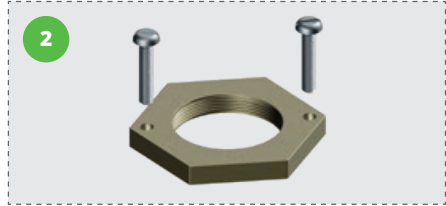
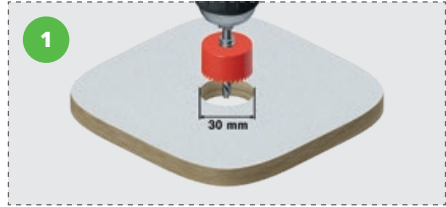
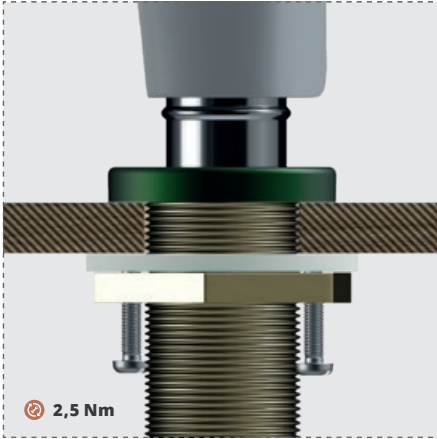

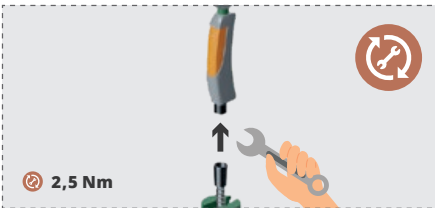
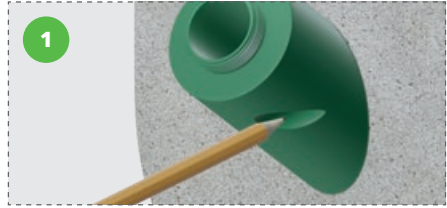
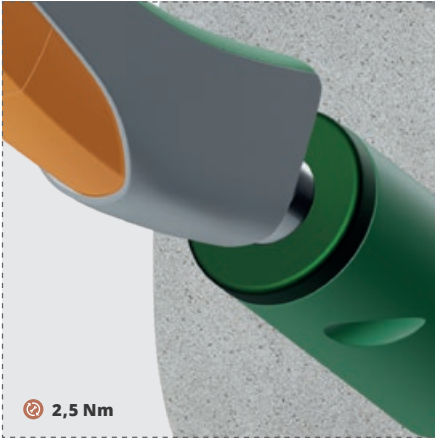

BR 200 0X5

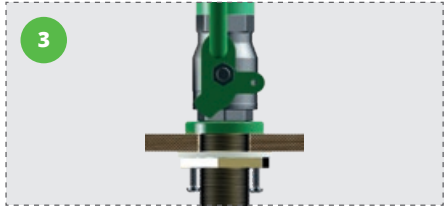
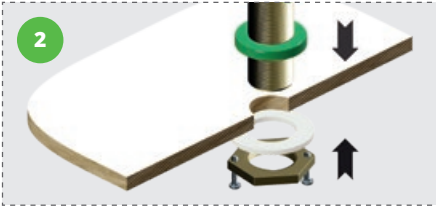
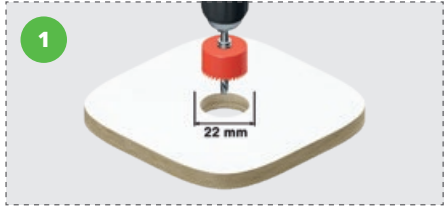

BR 210 0X5

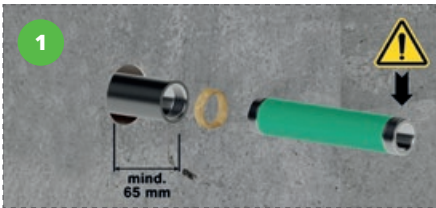
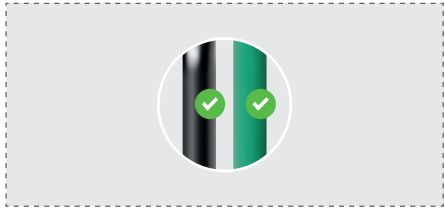

BR 210 0X5 + BR 861 XXX



BR 210 0X5 + BR 832 XXX

BR 250 XX5

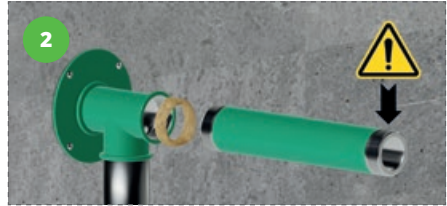
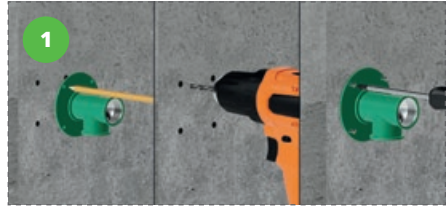

BR 250 4X5

BR 300 XX5

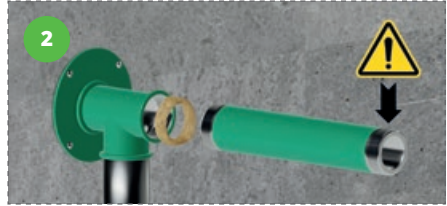
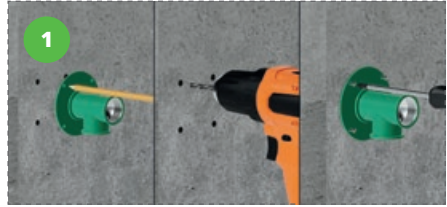

BR 300 4X5



BR 300 1X5 + BR 305 XX5



BR 300 1X5 + BR 867 XX5



BR 300 1X5 + BR 837 XX5



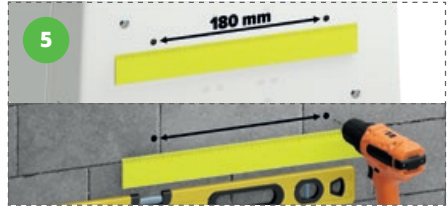

BR 850 005

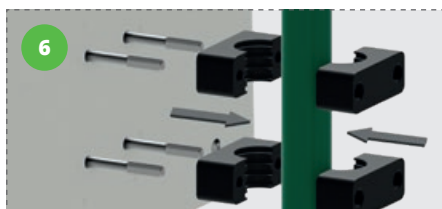
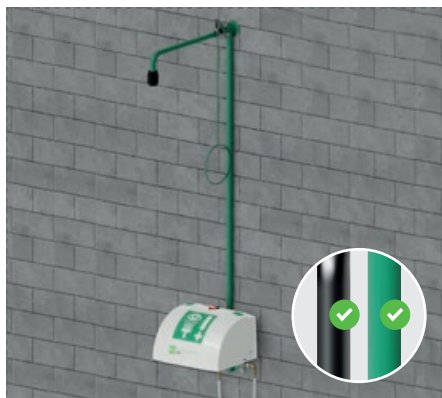

BR 850 005

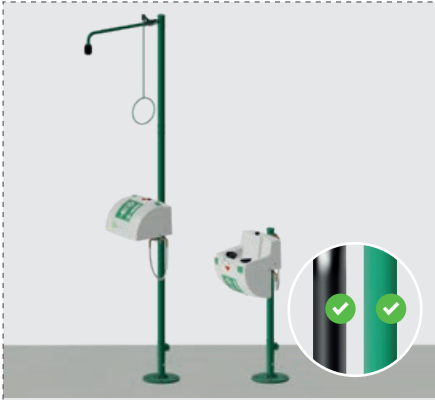

BR 850 005 + BR 838 XXX / BR 852 XXX

